

PALCO SOFA

Info

Palco is made up of a platform in teak or aluminum slats with a metal base and one or more padded elements, to be combined with each other to create different configurations, which can also be modified after purchase. The platform can be completely covered with padded elements or used as a low table, on which to place a lamp, a book or a cocktail.

The ideal location suggested by Kristalia for Palco is in covered and semi-covered verandas and terraces.

To improve the longevity of products made of teak, Kristalia recommends covering them with the special Casper covers.

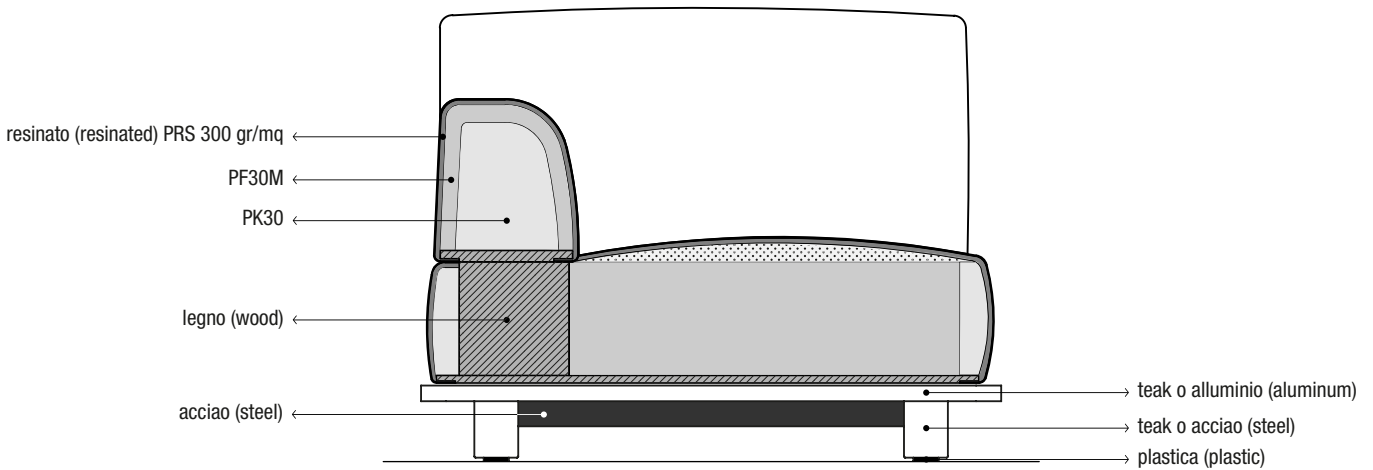
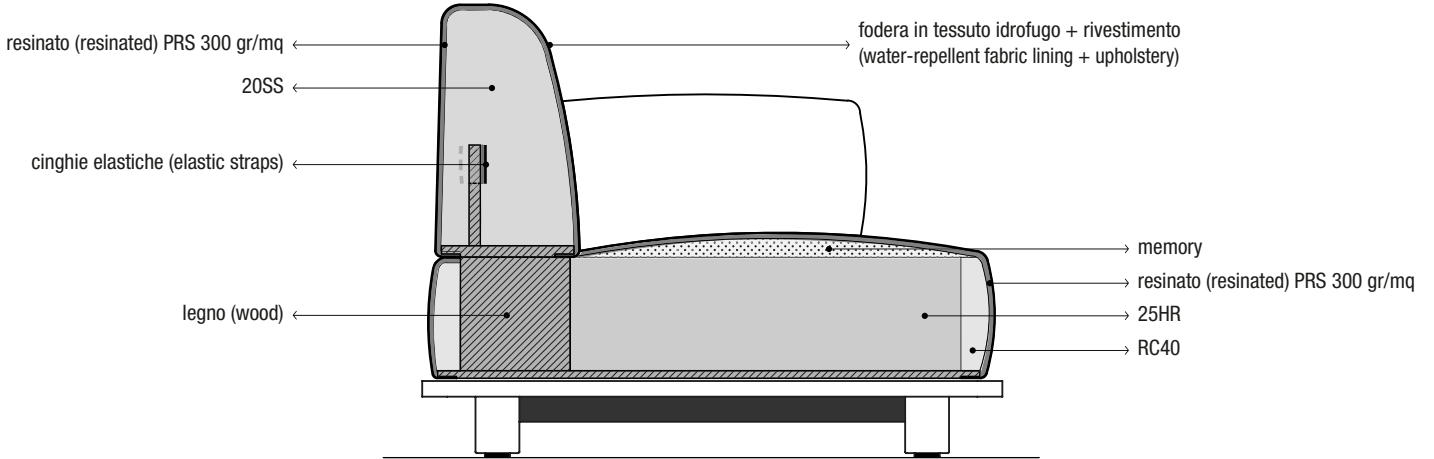

Heights:

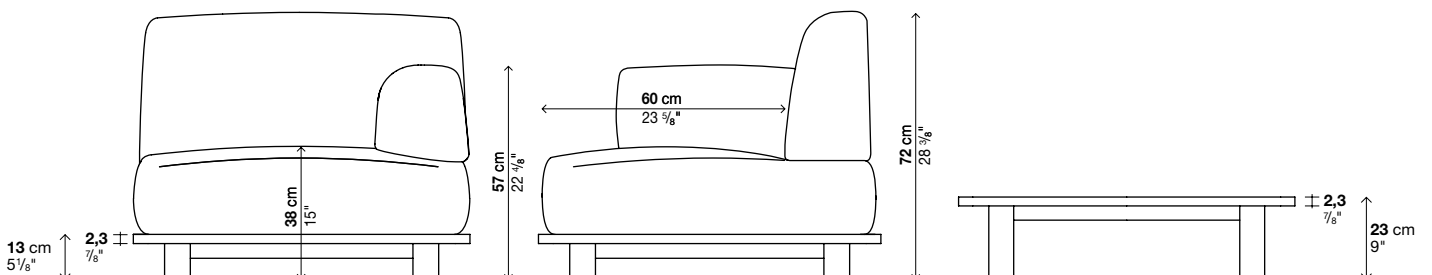

PALCO SOFA

Info

Platforms

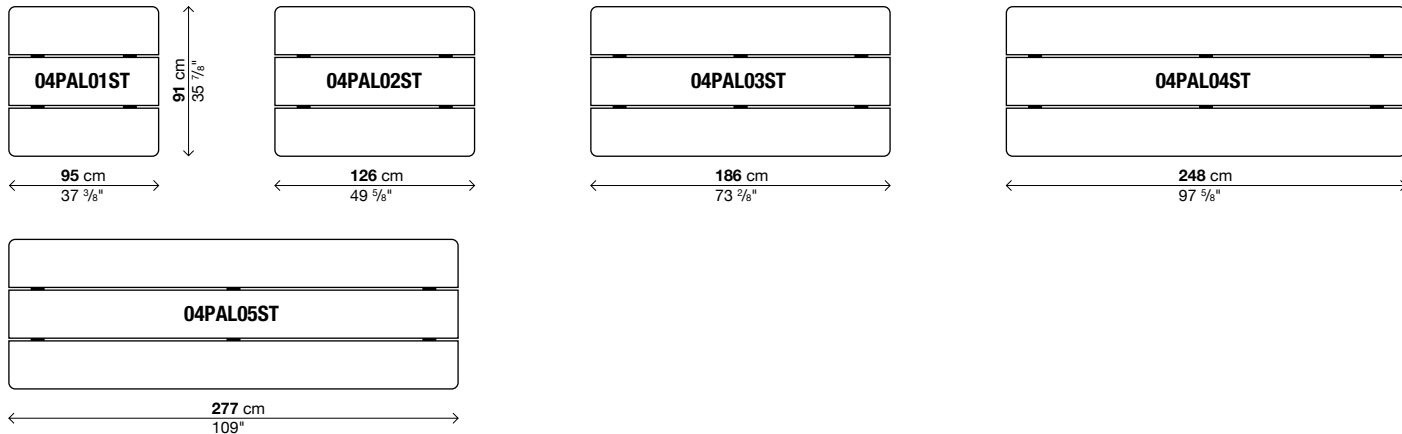

Padded elements 91 x 91 cm

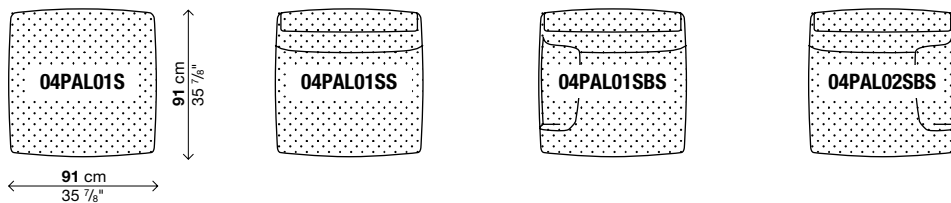

Padded elements 100 x 91 cm

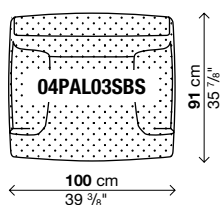

Occasional table

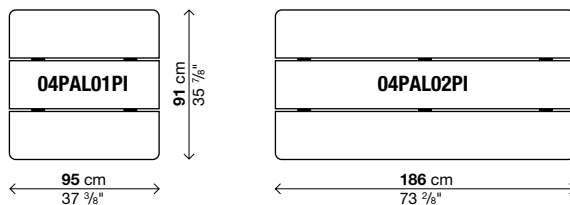

Padded elements 91 x 91 cm

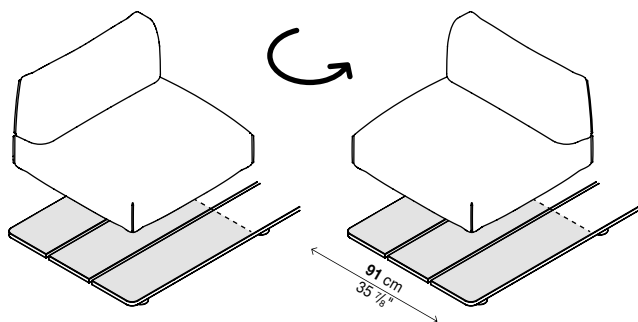

Padded elements 100 x 91 cm

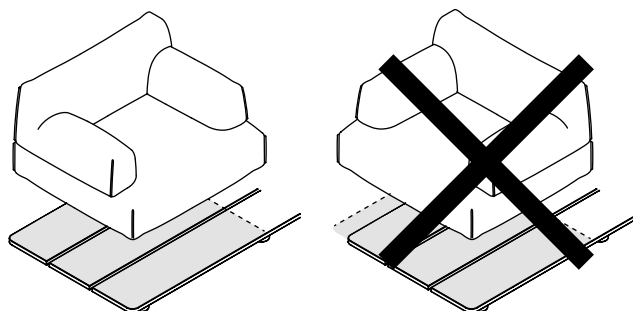

PALCO SOFA

Platform

Platform finish:

Champagne "Exclusive" lacquered aluminum

"Fenix-NTM® London grey" lacquered aluminum (similar to RAL Design0805005)

Black lacquered aluminium (similar to RAL 9004)

Terracotta brown lacquered aluminum (colour reference "Terracotta brown polyurethane PO06")

Olive green lacquered aluminum (colour reference "Olive green polyurethane PO08")

Teak

Finish of feet:

Lacquered steel (same colours as aluminum)

Teak

Finish of beam:

Black lacquered steel (similar to RAL 9004)

Aluminum slats

Code	Dimensions (L x D x H)	Feet	pack	m ²	Kg
		Lacquered steel			
04PAL11ST	95 x 91 x 12		1	0,23	38
04PAL12ST	126 x 91 x 12		1	0,29	47
04PAL13ST	186 x 91 x 12		1	0,43	67

Teak slats

Code	Dimensions (L x D x H)	Feet	pack	m ²	Kg
		Black lacquered steel, Teak			
04PAL01ST	95 x 91 x 12		1	0,23	37
04PAL02ST	126 x 91 x 12		1	0,29	46
04PAL03ST	186 x 91 x 12		1	0,43	66

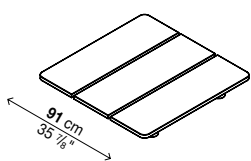

04PAL11ST
04PAL01ST

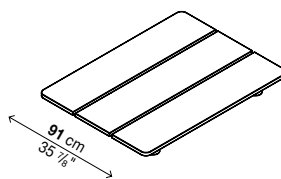
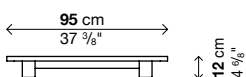

04PAL12ST
04PAL02ST

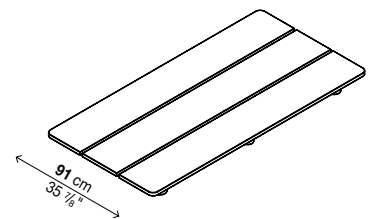
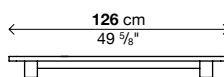

04PAL13ST
04PAL03ST

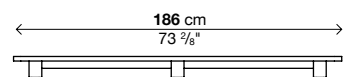

PALCO SOFA

Platform

Platform finish:

Champagne "Exclusive" lacquered aluminum

"Fenix-NTM® London grey" lacquered aluminum (similar to RAL Design0805005)

Black lacquered aluminium (similar to RAL 9004)

Terracotta brown lacquered aluminum (colour reference "Terracotta brown polyurethane PO06")

Olive green lacquered aluminum (colour reference "Olive green polyurethane PO08")

Teak

Finish of feet:

Lacquered steel (same colours as aluminum)

Teak

Finish of beam:

Black lacquered steel (similar to RAL 9004)

Aluminum slats

Code	Dimensions (L x D x H)	Feet	pack	m ³	Kg
		Lacquered steel			
04PAL14ST	248 x 91 x 12		1	0,58	85
04PAL15ST	277 x 91 x 12		1	0,64	99

Teak slats

Code	Dimensions (L x D x H)	Feet	pack	m ³	Kg
		Black lacquered steel, Teak			
04PAL04ST	248 x 91 x 12		1	0,58	83
04PAL05ST	277 x 91 x 12		1	0,64	97

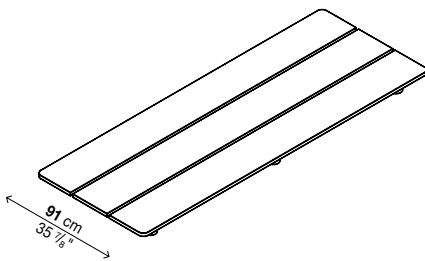

04PAL14ST
04PAL04ST

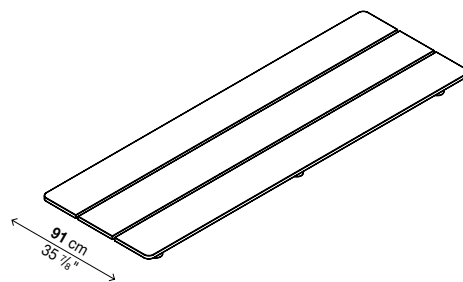

04PAL15ST
04PAL05ST

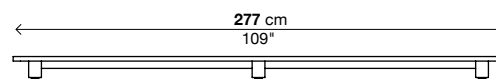
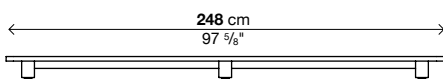

PALCO SOFA

Seat 91 x 91 cm

Finish of cover:

- A = COM (Customer fabric)
- B = Heritage, Natté
- C = Lopi, Patio
- E = RePo 3D

Note:

REMOVABLE COVERS:
Removable upholstery for the fabric versions.

For info on fabric composition, see inside cover.

For COM orders, see inside cover.

Pouf consumption:

COM: 1,4 ml (H. 140 cm).

Seat + backrest consumption:

COM: 2,5 ml (H. 140 cm).

Seat with right and left armrest consumption:

COM: 2,5 ml (H. 140 cm).

Fire retardant treatments available on request, please contact the sales office.

Reinforced packaging, see inside cover.

Pouf

Code	Cover					pack	m ²	Kg
	A	B	C		E			
04PAL01S						1	0,26	14

Seat + backrest

Code	Cover					pack	m ²	Kg
	A	B	C		E			
04PAL01SS						1	0,55	27

Seat with right and left armrest

Code	Description	Cover					pack	m ²	Kg
		A	B	C		E			
04PAL01SBS	Left armrest						1	0,55	30
04PAL02SBS	Right armrest						1	0,55	30

Optionals

Code	Description	pack	m ²	Kg
	Protective cover "Casper", see page 182	-	-	-

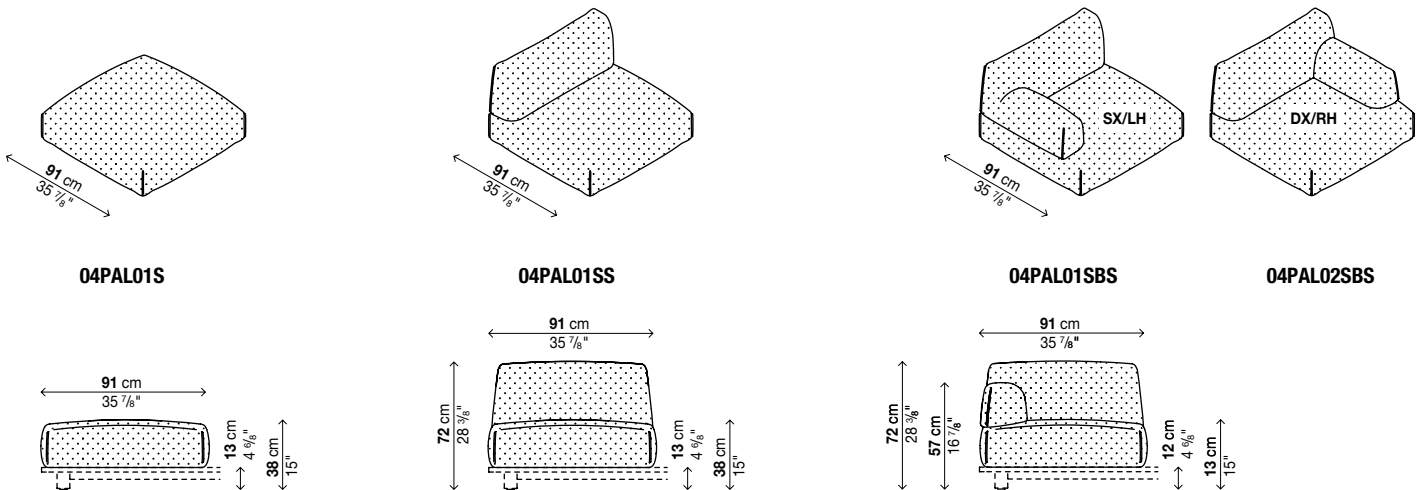

PALCO SOFA

Seat 100 x 91 cm

Finish of cover:

- A = COM (Customer fabric)
- B = Heritage, Natté
- C = Lopi, Patio
- E = RePo 3D

Note:

REMOVABLE COVERS:
Removable upholstery for the fabric versions.

For info on fabric composition, see inside cover.

For COM orders, see inside cover.

Seat with armrests consumption:
COM: 3,6 ml (H. 140 cm).

Fire retardant treatments available on request, please contact the sales office.

Reinforced packaging, see inside cover.

Seat with armrests

Code	Cover					pack	m ³	Kg
	A	B	C		E			
04PAL03SBS						1	0,61	34

Optionals

Code	Description	pack	m ³	Kg
	Protective cover "Casper", see page 182	-	-	-

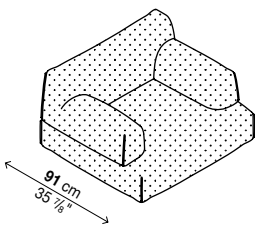

04PAL03SBS

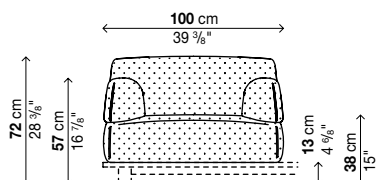

PALCO SOFA

Occasional table

Top finish:

Champagne "Exclusive" lacquered aluminum
 "Fenix-NTM® London grey" lacquered aluminum (similar to RAL Design0805005)
 Black lacquered aluminium (similar to RAL 9004)
 Terracotta brown lacquered aluminum (colour reference "Terracotta brown polyurethane PO06")
 Olive green lacquered aluminum (colour reference "Olive green polyurethane PO08")
 Teak

Finish of feet:

Lacquered steel (same colours as aluminum)
 Teak

Finish of beam:

Black lacquered steel (similar to RAL 9004)

Aluminum slats

Code	Dimensions (L x D x H)	Feet	pack	m ³	Kg
		Lacquered steel			
04PAL11PI	95 x 91 x 23		1	0,31	40
04PAL12PI	186 x 91 x 23		1	0,61	70

Teak slats

Code	Dimensions (L x D x H)	Feet	pack	m ³	Kg
		Black lacquered steel, Teak			
04PAL01PI	95 x 91 x 23		1	0,31	39
04PAL02PI	186 x 91 x 23		1	0,61	69

Optionals

Code	Description	pack	m ³	Kg
	Protective cover "Casper", see page 182	-	-	-

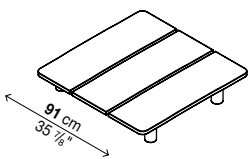

04PAL11PI
04PAL01PI

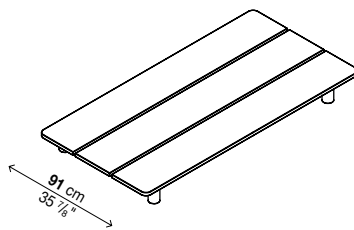

04PAL12PI
04PAL02PI

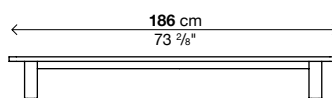
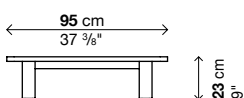

PALCO SOFA

Composition examples

Platform finish:

Champagne "Exclusive" lacquered aluminum
 "Fenix-NTM® London grey" lacquered aluminum (similar to RAL Design0805005)
 Black lacquered aluminium (similar to RAL 9004)
 Terracotta brown lacquered aluminum (colour reference "Terracotta brown polyurethane PO06")
 Olive green lacquered aluminum (colour reference "Olive green polyurethane PO08")
 Teak

Finish of feet:

Lacquered steel (same colours as aluminum)
 Teak

Finish of beam:

Black lacquered steel (similar to RAL 9004)

Finish of cover:

A = COM (Customer fabric)
 B = Heritage, Natté
 C = Lopi, Patio
 E = RePo 3D

Note:

REMOVABLE COVERS:
 Removable upholstery for the fabric versions.

For info on fabric composition, see inside cover.

For COM orders, see inside cover.

Composition 1 consumption:

COM: 1,4 ml (H. 140 cm).

Composition 2 consumption:

COM: 2,5 ml (H. 140 cm).

Fire retardant treatments available on request, please contact the sales office.

Reinforced packaging, see inside cover.

Composition 1

Code	Feet	Slats	Cover					pack	m ³	Kg
			A	B	C		E			
29PAL11	Lacquered steel	Aluminum						2	0,49	52
29PAL01	Black lacquered steel, Teak	Teak						2	0,49	51

Composition 2

Code	Feet	Slats	Cover					pack	m ³	Kg
			A	B	C		E			
29PAL12	Lacquered steel	Aluminum						2	0,84	74
29PAL02	Black lacquered steel, Teak	Teak						2	0,84	73

Optionals

Code	Description	pack	m ³	Kg
	Protective cover "Casper", see page 182	-	-	-

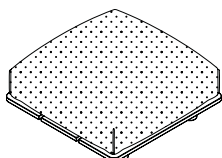

29PAL01
29PAL11

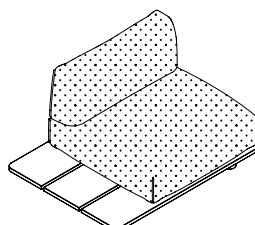
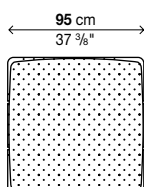

29PAL02
29PAL12

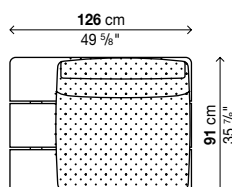

PALCO SOFA

Composition examples

Platform finish:

Champagne "Exclusive" lacquered aluminum
 "Fenix-NTM® London grey" lacquered aluminum (similar to RAL Design0805005)
 Black lacquered aluminium (similar to RAL 9004)
 Terracotta brown lacquered aluminum (colour reference "Terracotta brown polyurethane PO06")
 Olive green lacquered aluminum (colour reference "Olive green polyurethane PO08")
 Teak

Finish of feet:

Lacquered steel (same colours as aluminum)
 Teak

Finish of beam:

Black lacquered steel (similar to RAL 9004)

Finish of cover:

A = COM (Customer fabric)
 B = Heritage, Natté
 C = Lopi, Patio
 E = RePo 3D

Note:

REMOVABLE COVERS:
 Removable upholstery for the fabric versions.

For info on fabric composition, see inside cover.

For COM orders, see inside cover.

Composition 3 consumption:

COM: 5 ml (H. 140 cm).

Composition 4 consumption:

COM: 7,5 ml (H. 140 cm).

Fire retardant treatments available on request, please contact the sales office.

Reinforced packaging, see inside cover.

Composition 3

Code	Feet	Slats	Cover					pack	m ³	Kg
			A	B	C		E			
29PAL13	Lacquered steel	Aluminum						3	1,53	121
29PAL03	Black lacquered steel, Teak	Teak						3	1,53	120

Composition 4

Code	Feet	Slats	Cover					pack	m ³	Kg
			A	B	C		E			
29PAL14	Lacquered steel	Aluminum						4	2,29	186
29PAL04	Black lacquered steel, Teak	Teak						4	2,29	184

Optionals

Codice	Description	pack	m ³	Kg
	Protective cover "Casper", see page 182	-	-	-

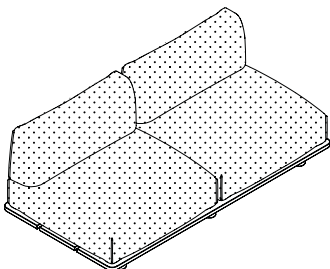

29PAL03
29PAL13

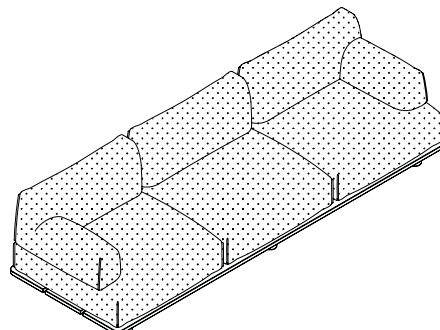
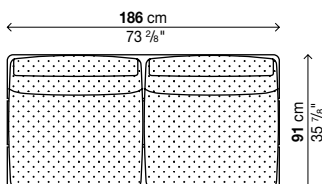

29PAL04
29PAL14

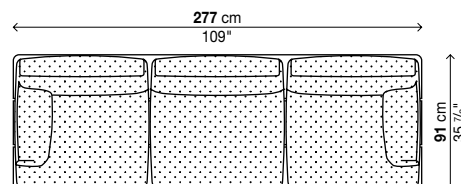

PALCO SOFA

Composition examples

Platform finish:

Champagne "Exclusive" lacquered aluminum
 "Fenix-NTM® London grey" lacquered aluminum (similar to RAL Design0805005)
 Black lacquered aluminium (similar to RAL 9004)
 Terracotta brown lacquered aluminum (colour reference "Terracotta brown polyurethane P006")
 Olive green lacquered aluminum (colour reference "Olive green polyurethane P008")
 Teak

Finish of feet:

Lacquered steel (same colours as aluminum)
 Teak

Finish of beam:

Black lacquered steel (similar to RAL 9004)

Finish of cover:

A = COM (Customer fabric)
 B = Heritage, Natté
 C = Lopi, Patio
 E = RePo 3D

Note:

REMOVABLE COVERS:
 Removable upholstery for the fabric versions.

For info on fabric composition, see inside cover.

For COM orders, see inside cover.

Composition 5 consumption:

COM: 3,9 ml (H. 140 cm).

Composition 6 consumption:

COM: 6,4 ml (H. 140 cm).

Fire retardant treatments available on request, please contact the sales office.

Reinforced packaging, see inside cover.

Composition 5

Code	Feet	Slats	Cover					pack	m ³	Kg
			A	B	C		E			
29PAL15	Lacquered steel	Aluminum						3	1,39	125
29PAL05	Black lacquered steel, Teak	Teak						3	1,39	124

Composition 6

Code	Feet	Slats	Cover					pack	m ³	Kg
			A	B	C		E			
29PAL16	Lacquered steel	Aluminum						4	2,29	186
29PAL06	Black lacquered steel, Teak	Teak						4	2,29	184

Optionals

Codice	Description	pack	m ³	Kg
	Protective cover "Casper", see page 182	-	-	-

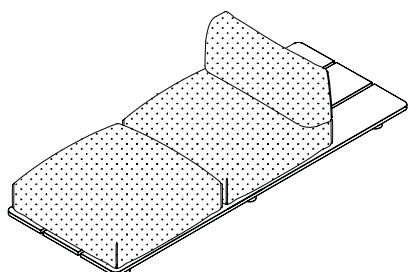

29PAL05
29PAL15

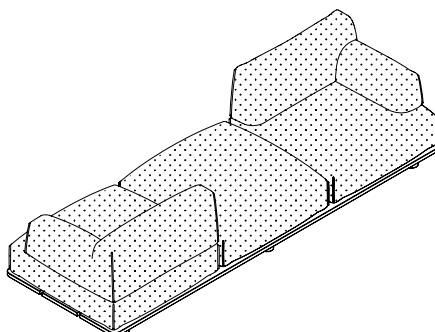

29PAL06
29PAL16

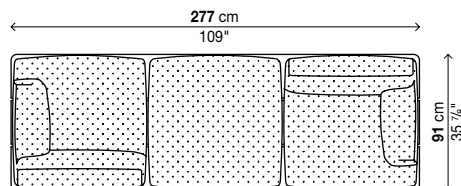
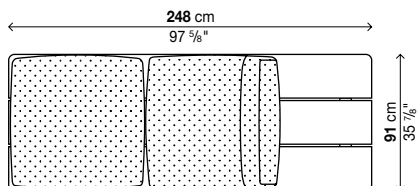

PALCO SOFA

Composition examples

Platform finish:

Champagne "Exclusive" lacquered aluminum
 "Fenix-NTM® London grey" lacquered aluminum (similar to RAL Design0805005)
 Black lacquered aluminium (similar to RAL 9004)
 Terracotta brown lacquered aluminum (colour reference "Terracotta brown polyurethane PO06")
 Olive green lacquered aluminum (colour reference "Olive green polyurethane PO08")
 Teak

Finish of feet:

Lacquered steel (same colours as aluminum)
 Teak

Finish of beam:

Black lacquered steel (similar to RAL 9004)

Finish of cover:

A = COM (Customer fabric)
 B = Heritage, Natté
 C = Lopi, Patio
 E = RePo 3D

Note:

REMOVABLE COVERS:
 Removable upholstery for the fabric versions.

For info on fabric composition, see inside cover.

For COM orders, see inside cover.

Composition 7 consumption:

COM: 3,6 ml (H. 140 cm).

Composition 8 consumption:

COM: 5 ml (H. 140 cm).

Fire retardant treatments available on request, please contact the sales office.

Reinforced packaging, see inside cover.

Composition 7

Code	Feet	Slats	Cover					pack	m ³	Kg
			A	B	C		E			
29PAL17	Lacquered steel	Aluminum						2	0,9	81
29PAL07	Black lacquered steel, Teak	Teak						2	0,9	80

Composition 8

Code	Feet	Slats	Cover					pack	m ³	Kg
			A	B	C		E			
29PAL18	Lacquered steel	Aluminum						3	1,68	145
29PAL08	Black lacquered steel, Teak	Teak						3	1,68	143

Optionals

Codice	Description	pack	m ³	Kg
	Protective cover "Casper", see page 182	-	-	-

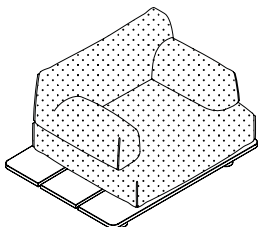

29PAL07
29PAL17

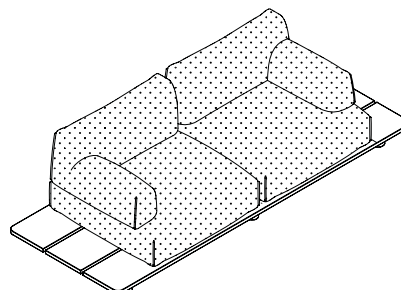
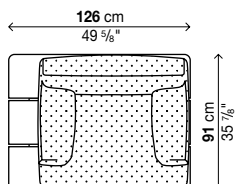

29PAL08
29PAL18

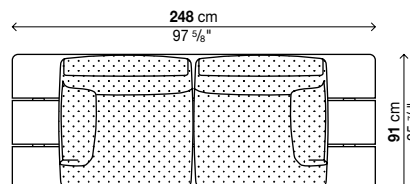

PALCO SOFA

Composition examples

Platform finish:

Champagne "Exclusive" lacquered aluminum
 "Fenix-NTM® London grey" lacquered aluminum (similar to RAL Design0805005)
 Black lacquered aluminium (similar to RAL 9004)
 Terracotta brown lacquered aluminum (colour reference "Terracotta brown polyurethane PO06")
 Olive green lacquered aluminum (colour reference "Olive green polyurethane PO08")
 Teak

Finish of feet:

Lacquered steel (same colours as aluminum)
 Teak

Finish of beam:

Black lacquered steel (similar to RAL 9004)

Finish of cover:

A = COM (Customer fabric)
 B = Heritage, Natté
 C = Lopi, Patio
 E = RePo 3D

Note:

REMOVABLE COVERS:
 Removable upholstery for the fabric versions.

For info on fabric composition, see inside cover.

For COM orders, see inside cover.

Composition 9 consumption:
 COM: 10 ml (H. 140 cm).

Fire retardant treatments available on request, please contact the sales office.

Reinforced packaging, see inside cover.

Composition 9

Code	Feet	Slats	Cover					pack	m ³	Kg
			A	B	C		E			
29PAL19	Lacquered steel	Aluminum						6	3,27	280
29PAL09	Black lacquered steel, Teak	Teak						6	3,27	277

Optionals

Codice	Description	pack	m ³	Kg
	Protective cover "Casper", see page 182	-	-	-

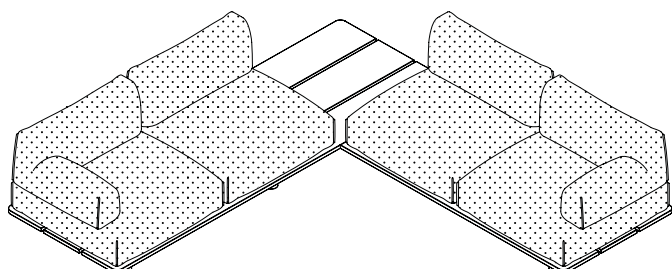

29PAL09
29PAL19

