

Bistroo

© design by Dirk Wynants



Dimensions

The Bistoo is available in 1 dimension

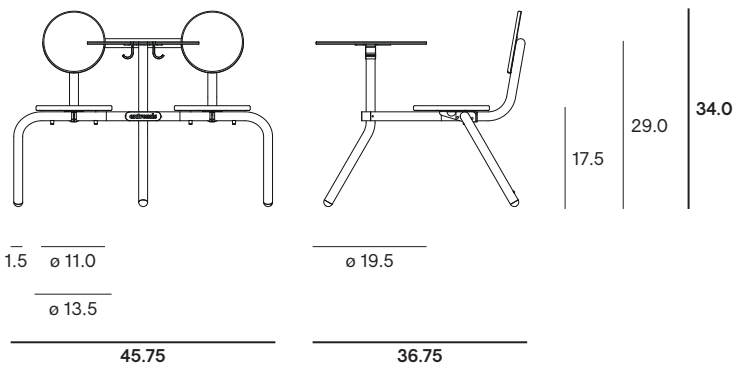

Box dimensions

The Bistoo comes in 1 box

Box 1: Bistoo

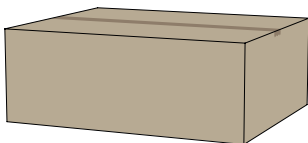

Box dimensions (inch)		L	W	H	Qty	Volume (ft ³)	Gross weight (lb)	Net weight (lb)	Packaging weight (lb)
Bistoo	Box 1	29.0	24.0	11.0	1	4.59	61.73	52.03	9.70

Table tray

The table tray is available in 1 dimension



Table tray box

The table tray comes in 1 box

Box 3: table tray



Box dimensions (inch)		L	W	H	Qty	Volume (ft ³)	Gross weight (lb)	Net weight (lb)	Packaging weight (lb)
Table tray	Box 3	10.5	8.5	2.0	1	0.35	0.93	0.51	0.42

Cushions

The cushion is available in 1 dimension

The optional cushions are delivered inside the box with the Bistroo: 0,68 lb/pc

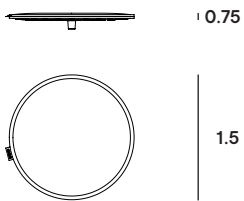

Floor fastening

The floor fastening is available in 1 dimension



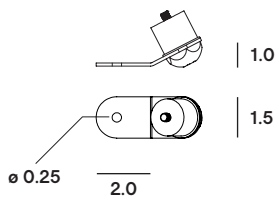





The optional floor fastening is delivered inside the box with the Bistroo: 0,29 lb/pc

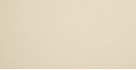

Materials & colors

Check price list or www.extremis.com for current materials & colors

Tabletop, frame, seats & backrests

	Off white (RAL9002) Structured powder coating
	Verdigris Structured powder coating
	Reed green (RAL6013) Structured powder coating
	Copper brown (RAL8004) Structured powder coating
	Cosmic cream (RAL1015) Structured powder coating
	Cobalt blue (RAL5013) Structured powder coating
	Sun yellow (RAL1032) Structured powder coating
	Pistache (RAL6021) Structured powder coating

Sunbrella® cushions









	Grey chiné Sunbrella Natté
	Dark taupe Sunbrella Natté
	Marble Sunbrella Lopi
	Charcoal Sunbrella Lopi
	Leaf green Sunbrella Heritage
	Indigo Sunbrella Heritage
	Loto Sunbrella Domino
	Craps Sunbrella Domino

Table tray



Materials	Key facts	Thickness	Layer thickness	Density	In/outdoor	Water	UV color fastness	Flame retarding
		inch	micron					
Structured powder-coated aluminium tabletop, seats & backrests	<ul style="list-style-type: none"> A technique of applying dry paint to a part Electrostatically charged and sprayed onto the object Placed in an oven and powder particles melt and coalesce to form a continuous film More scratch-resistant than non structured powder-coating 	0.39	50 - 100	0.47 10 ³ lb/m ³	Outdoor & indoor	n.a.	Very good: color can fade to some extent when exposed to UV	NEN-EN 13501-1 A2-s1*
Structured powder-coated stainless steel legs	<ul style="list-style-type: none"> Easy to clean Stainless steel (for protection against rust), then powder-coated Placed in an oven and powder particles melt and coalesce to form a continuous film More scratch-resistant than non structured powder-coating 	0.08	50-100	0.50 10 ³ lb/m ³	Outdoor & indoor	n.a.	Very good: color can fade to some extent when exposed to UV	NEN-EN13501-1 A1 *
Bamboo table tray	<ul style="list-style-type: none"> Oiled for better dirt resistance 	0.79	n.a.	37 à 44 lb/m ³	Outdoor & indoor	n.a.	Wood turns grey after a while	/
Sunbrella® cushions	<ul style="list-style-type: none"> 100% Sunbrella Acrylic Best outdoor fabric available for making cushions Dirt repellent Not waterproof, store inside! Machine washable at max. 30°C. Ironing restores the protective layer 	0.01	n.a.	9.53 oz/ft ²	Outdoor & indoor	The fabric has a water column of 350 mm (EN 20811)	7/8 (ISO 105-B02)	/
Stainless steel AISI 316 floor fastening	<ul style="list-style-type: none"> High rust resistance Periodical maintenance required 	0.06	n.a.	0.50 10 ³ lb/m ³	Outdoor & indoor version	n.a.	Very good	NEN-EN13501-1 A1 *

NEN-EN13501-1 A1

Class A1 products will not contribute to fire in any stage, including fully developed fire. For this reason, they are assumed to be capable of satisfying all requirements of all lower classes as well.

NEN-EN13501-1 A2-sl

Satisfying the same criteria as class B for the SBI-test according to EN 13823. In addition, under conditions of a fully developed fire these products will not significantly contribute to the fire load and fire growth

Good to know

- Fits on a terrace or balcony of 47.25 x 47.25 inch.
- Water draining seat.
- Bistroo combines perfectly with Virus.
- Tabletop cut-out to fix accessories.



- Stackable up to 4 pieces.



Maintenance

POWDER COATED PARTS

- White powder coating obviously requires more maintenance.

SUNBRELLA

- Shake or brush off loose dirt immediately.
- Spray Extremis Multi Cleaner.
- Use a soft brush and make circular movements.
- Let the suds soak in for a moment.
- Rinse thoroughly to remove all soap residue.
- Simply allow to dry.
- It's also possible to put the blanket and the pillow covers in a washing machine (max 40°C). Follow the cleaning instruction on the label.

Floor fastening

Our Bistroo picnic table can be fixed to the floor, to prevent them from being moved, or worse, from being stolen. However, attaching it to the floor is not always enough, as bolts can always be unscrewed. We offer a connection piece that replaces the end cap at the bottom of a table leg.



F.A.Q.

Q: Is it possible to stack the table?

A: It is possible. You can stack Bistroo up to 4 pieces. To avoid damage, use blankets.

Q: Is it easy to move the table?

A: The table is very light, so it can be moved easily.

Warnings

General

- Do not use any sharp tools to open the packaging.
- We strongly advise against using power tools.
- Tripping hazard, mind your step.
- Do not put out cigarettes on the table.
- Not graffiti proof.
- Do not leave children unattended whilst playing on the table.
- To avoid danger of suffocation, keep plastic bags away from babies and children.
- Colors can differ over years and from batch to batch.

Product

- Anchoring the product has to be done by qualified people.

- For anchoring: use suitable bolts or screws from a specialized store depending on the material your terrace is made of.
- Stackable up to 4 pieces.
- Always stack the tables with 2 people.
- Only use Extremis accessories.
- Do not sit on the tabletop.
- Do not stand or jump on the seat or the tabletop.
- Max. 1 person or 264 lb per seat.

Powder coating

- White powder coating requires more maintenance.
- Do not use abrasive scouring powders or scourers as they will scratch the surface.
- Color can fade to some extent when exposed to UV.
- Flame retarding - NEN-EN13501-1 A2-sl -

Satisfying the same criteria as Class B for the SBI-test according to EN13823. In addition, under conditions of a fully developed fire these products will not significantly contribute to the fire load and fire growth.

- Dark colors can get very hot in sunny weather.

Sunbrella

- Not waterproof, store inside!
- Shake or brush off loose dirt immediately.
- UV color fastness: 7/8 (ISO 105-B02).